



Report

US \$44.99

2017 Dodge Grand Caravan GT

177,510 mi | VIN: 2C4RDGEG9HR858675

Van | 3.6L V6 F DOHC 24V | Gasoline | Front wheel drive

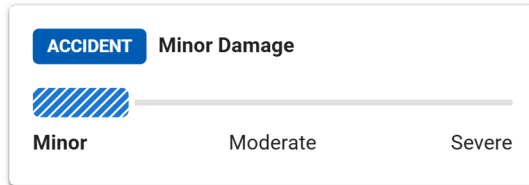

9 Service History Records

3 Previous Owners

Types of Owners: Rental, Personal

Last Owned in North Carolina

32 Detailed Records Available

This CARFAX Vehicle History Report is based only on information supplied to CARFAX and available as of 6/23/26 at 5:54:13 PM (CDT). Other information about this vehicle, including problems, may not have been reported to CARFAX. Use this report as one important tool, along with a vehicle inspection and test drive, to make a better decision about your next used car.



Accident / Damage History

Not all accidents / issues are reported to CARFAX

Event 1

01/25/2018

Damage reported: minor damage

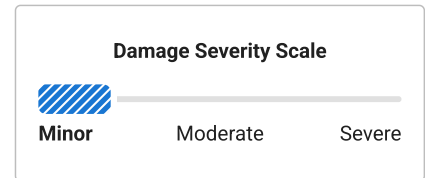

Event 2

07/25/2018

Accident reported: minor damage

- Vehicle involved in a rear-end collision with another motor vehicle
- Airbags did not deploy

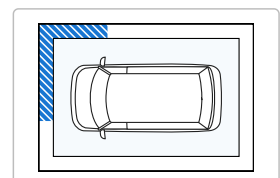
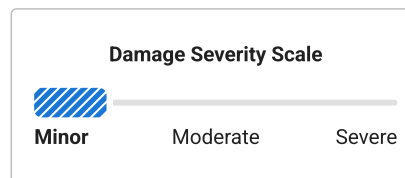

Recent Service Highlights

Key services performed in the last 12 months

Service	Comments	Date



✓ Oil and filter changed

07/19/2025



✓ Rear brake rotor(s) replaced

07/19/2025

This car has been recently serviced. That's a good thing!



Additional History

Not all accidents / issues are reported to CARFAX

Owner 1

Owner 2

Owner 3

Total Loss

No total loss reported to CARFAX.

✓ No Issues Reported

✓ No Issues Reported

✓ No Issues Reported

Structural Damage

CARFAX recommends that you have this vehicle inspected by a collision repair specialist.

✓ No Issues Reported

✓ No Issues Reported

✓ No Issues Reported

Airbag Deployment

No airbag deployment reported to CARFAX.

✓ No Issues Reported

✓ No Issues Reported

✓ No Issues Reported

Odometer Check

No indication of an odometer rollback.

✓ No Issues Indicated

✓ No Issues Indicated

✓ No Issues Indicated

Accident / Damage

Damage reported: 01/25/2018. Accident reported: 07/25/2018.

Minor Damage

No New Issues Reported

No New Issues Reported

Manufacturer Recall

No open recalls reported to CARFAX.

✓ No Recalls Reported

✓ No Recalls Reported

✓ No Recalls Reported



Title History

CARFAX guarantees the information in this section

Owner 1

Owner 2

Owner 3

Damage Brands

Salvage | Junk | Rebuilt | Fire | Flood | Hail | Lemon

✓ Guaranteed No Problem

✓ Guaranteed No Problem

✓ Guaranteed No Problem

Odometer Brands

Not Actual Mileage | Exceeds Mechanical Limits

✓ Guaranteed No Problem

✓ Guaranteed No Problem

✓ Guaranteed No Problem



GUARANTEED - None of these title problems were reported by a U.S. state Department of Motor Vehicles (DMV). If you find that any of these title problems were reported by a DMV and not included in this report, you may qualify. [View Terms](#) | [View Certificate](#)



Ownership History

The number of owners is estimated

Owner 1

Owner 2

Owner 3

Year purchased

2017

2019

2020

Type of owner

Rental

Personal

Rental

Estimated length of ownership

1 yr. 5 mo.

1 yr. 4 mo.

5 yrs. 7 mo.

Owned in the following states/provinces

Ohio

North Carolina, Ohio

North Carolina

Estimated miles driven per year

33,379/yr

16,131/yr

17,905/yr

Last reported odometer reading

48,699

75,654

177,510





Detailed History



Owner 1

Purchased: 2017

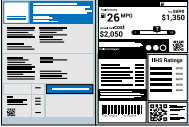
Rental Vehicle
33,379 mi/yr

Date	Mileage	Source	Comments
Not Reported		FCA	Original Window Sticker 
08/15/2017	10	Ohio Motor Vehicle Dept. Cincinnati, OH	Vehicle purchase reported - Titled or registered as rental vehicle
08/16/2017		Ohio Motor Vehicle Dept. Tulsa, OK Title #1302861836	Title issued or updated - First owner reported
08/21/2017		Ohio Motor Vehicle Dept. Cincinnati, OH Title #1302861836	Registration issued or renewed
01/03/2018		Ohio Motor Vehicle Dept. Cincinnati, OH Title #1302861836	Registration issued or renewed
01/09/2018	15,338	Tire Discounters Miamisburg, OH 937-433-2900 ★ 4.4 / 5.0 271 Verified Reviews ❤️ 1,043 Customer Favorites	 Vehicle serviced - Oil and filter changed
01/25/2018		Damage Report	Damage reported: minor damage <div data-bbox="849 1066 1255 1224" style="border: 1px solid #ccc; padding: 5px; margin: 10px 0;"> <p style="text-align: center;">Damage Severity Scale</p> <div style="display: flex; align-items: center;"> <div style="width: 20px; height: 10px; background: repeating-linear-gradient(45deg, transparent, transparent 2px, #007bff 2px, #007bff 4px); margin-right: 5px;"></div> <div style="flex-grow: 1; border-bottom: 1px solid #ccc; position: relative;"> <div style="position: absolute; left: -20px; top: -5px;">Minor</div> <div style="position: absolute; right: -20px; top: -5px;">Moderate</div> <div style="position: absolute; right: -20px; top: -5px;">Severe</div> </div> </div> </div> <div data-bbox="876 1249 1507 1323" style="border: 1px solid #007bff; border-radius: 5px; padding: 5px; margin-top: 10px;"> <p>Minor damage is usually cosmetic, including dents or scratches to the vehicle body.</p> </div>
07/25/2018		Damage Report	Accident reported: minor damage - Vehicle involved in a rear-end collision with another motor vehicle - Damage to right front - Damage to front - Airbags did not deploy <div data-bbox="849 1539 1255 1696" style="border: 1px solid #ccc; padding: 5px; margin-top: 10px;"> <p style="text-align: center;">Damage Severity Scale</p> <div style="display: flex; align-items: center;"> <div style="width: 20px; height: 10px; background: repeating-linear-gradient(45deg, transparent, transparent 2px, #007bff 2px, #007bff 4px); margin-right: 5px;"></div> <div style="flex-grow: 1; border-bottom: 1px solid #ccc; position: relative;"> <div style="position: absolute; left: -20px; top: -5px;">Minor</div> <div style="position: absolute; right: -20px; top: -5px;">Moderate</div> <div style="position: absolute; right: -20px; top: -5px;">Severe</div> </div> </div> </div>

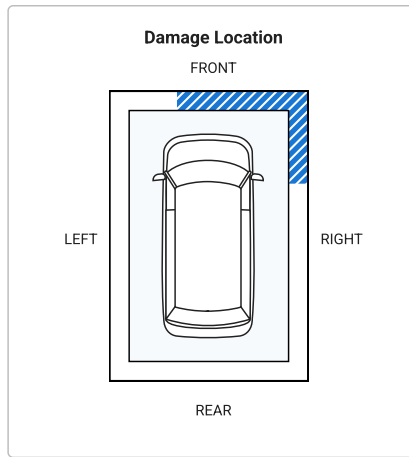

Minor damage is usually cosmetic, including dents or scratches to the vehicle body.

01/28/2019	48,570	Fleet/Lease Company		Vehicle sold
01/31/2019		Dealer Inventory		Vehicle offered for sale
01/31/2019	48,699	Hyundai of Asheville Asheville, NC 828-298-4911 ★ 4.4 / 5.0 714 Verified Reviews ♥ 5,232 Customer Favorites		Vehicle serviced - Maintenance inspection completed - Air filter replaced - Brakes checked - Cabin air filter replaced/cleaned - Four tires balanced - Four wheel alignment performed - Front brake pads replaced - Front brake rotor(s) resurfaced - Front wiper blades/refills replaced - Fuel system cleaned/serviced - Emissions or safety inspection performed - Oil and filter changed - Tires rotated - Vehicle washed/detailed



Owner 2
Purchased: 2019 Personal Vehicle
16,131 mi/yr

Date	Mileage	Source		Comments
03/08/2019		North Carolina Motor Vehicle Dept. Asheville, NC Title #77093919067429J		Title or registration issued - New owner reported - Loan or lien reported
03/11/2019		Ohio Motor Vehicle Dept. Cincinnati, OH Title #1302861836		Registration issued or renewed
04/04/2019	53,954	Hyundai of Asheville Asheville, NC 828-298-4911 ★ 4.4 / 5.0 714 Verified Reviews ♥ 5,232 Customer Favorites		Vehicle serviced - Maintenance inspection completed - Oil and filter changed
05/31/2019	56,780	Hyundai of Asheville Asheville, NC 828-298-4911 ★ 4.4 / 5.0 714 Verified Reviews ♥ 5,232 Customer Favorites		Vehicle serviced - Maintenance inspection completed - Oil and filter changed - Vehicle washed/detailed
07/11/2019		North Carolina Motor Vehicle Dept. Asheville, NC		Registration issued or renewed - Loan or lien reported

Title #77093919067429J

08/07/2020	75,654	Hyundai of Asheville Asheville, NC	Vehicle offered for sale
08/14/2020		Hyundai of Asheville Asheville, NC 828-298-4911 ★ 4.4 / 5.0 714 Verified Reviews ♥ 5,232 Customer Favorites	 Vehicle serviced - Maintenance inspection completed - Air filter replaced - Four tires balanced - Four wheel alignment performed - Fuel system cleaned/serviced - Emissions inspection performed - Oil and filter changed - Tires rotated
Looks like this dealer serviced the car in order to prepare it for sale. That's a good thing!			

 **Owner 3** Rental Vehicle
Purchased: 2020 17,905 mi/yr

Date	Mileage	Source	Comments
10/03/2020	75,812	North Carolina Motor Vehicle Dept. Canton, NC	Odometer reading reported
10/27/2020		North Carolina Motor Vehicle Dept. Canton, NC Title #771109203016297	Title or registration issued - New owner reported - Loan or lien reported
03/03/2021		North Carolina Motor Vehicle Dept. Canton, NC Title #771109203016297	Registration issued or renewed - Loan or lien reported
12/03/2021		North Carolina Motor Vehicle Dept. Canton, NC Title #771109203016297	Registration issued or renewed - Loan or lien reported
01/18/2023		North Carolina Motor Vehicle Dept. Canton, NC Title #771109203016297	Registration issued or renewed - Loan or lien reported
01/10/2024		North Carolina Motor Vehicle Dept. Canton, NC Title #771109203016297	Registration issued or renewed - Loan or lien reported
01/20/2024	139,986	Mr. Tire Auto Service Centers Waynesville, NC 828-456-9468 ★ 4.2 / 5.0 53 Verified Reviews ♥ 2 Customer Favorites	 Vehicle serviced - Maintenance inspection completed - Recommended maintenance performed - Tire(s) mounted
01/31/2025		North Carolina Motor Vehicle Dept. Canton, NC Title #771109203016297	Registration issued or renewed - Loan or lien reported
07/01/2025	165,261	Fields Chrysler Jeep Dodge RAM Asheville Asheville, NC 828-667-5213 ★ 4.6 / 5.0 752 Verified Reviews ♥ 291 Customer Favorites	 Vehicle serviced - Maintenance inspection completed - Vehicle washed/detailed
07/19/2025	165,964	Singletons Automotive Canton, NC	 Vehicle serviced - Air filter checked

828-648-8300

★ 5.0 / 5.0 20 Verified Reviews

♥ 8 Customer Favorites

- Body lubricated
- Fluids checked
- Fuel system cleaned/serviced
- Intake manifold gasket(s) replaced
- Oil and filter changed
- Oil pressure sender/switch replaced
- PCV valve replaced
- Rear brake rotor(s) replaced
- Spark plug(s) replaced
- Tire condition and pressure checked

02/06/2026		North Carolina Motor Vehicle Dept. Canton, NC Title #771109203016297		Registration issued or renewed - Loan or lien reported
05/07/2026		Online Listing		Vehicle offered for sale
06/05/2026	177,405	AutoStar Chrysler Dodge Jeep Ram Fiat Waynesville Waynesville, NC 828-452-2841 ★ 4.7 / 5.0 96 Verified Reviews ♥ 37 Customer Favorites		Vehicle serviced
06/15/2026	177,510	Auto Auction		Vehicle sold

Make sure you buy this car from a licensed dealership or you may be a victim of curbstoning, which is illegal. A curbstoner poses as a private seller to sell vehicles for a large profit. Not cool!

Have Questions? Please visit our Help Center at www.carfax.com.



Glossary

Accident Indicator

CARFAX receives information about accidents in all 50 states, the District of Columbia and Canada.

Not every accident is reported to CARFAX. As details about the accident become available, those additional details are added to the CARFAX Vehicle History Report. CARFAX recommends that you have this vehicle inspected by a qualified mechanic.

- According to the National Safety Council, Injury Facts, 2021 edition, 5% of the 276 million registered vehicles in the U.S. were involved in an accident in 2019. Over 77% of these were considered minor or moderate.
- This CARFAX Vehicle History Report is based only on information supplied to CARFAX and available as of 6/23/26 at 5:54:13 PM (CDT). Other information about this vehicle, including problems, may not have been reported to CARFAX. Use this report as one important tool, along with a vehicle inspection and test drive, to make a better decision about your next used car.

Damage Indicator

Damage can be a result of many different types of events. Examples include contact with objects (other cars, trees, traffic signs, road debris, etc), vandalism, or weather-related events. Not every damage event is reported to CARFAX. As details about the damage event become available, those additional details are added to the CARFAX Vehicle History Report. CARFAX recommends that you have this vehicle inspected by a qualified mechanic.

- This CARFAX Vehicle History Report is based only on information supplied to CARFAX and available as of 6/23/26 at 5:54:13 PM (CDT). Other information about this vehicle, including problems, may not have been reported to CARFAX. Use this report as one important tool, along with a vehicle inspection and test drive, to make a better decision about your next used car.

Damage Severity

Damage events result in one of the following severity levels:

- Minor: Generally, minor damage is cosmetic (including dents or scratches), may only require reconditioning, and typically does not compromise a vehicle's operation and/or safety.
- Moderate: Moderate damage may affect multiple components of the vehicle and may impair the vehicle's operation and/or safety.
- Severe: Severe damage usually affects multiple components of the vehicle and is likely to compromise the vehicle's operation and/or safety.

CARFAX recommends getting a pre-purchase inspection at a certified collision repair facility.

First Owner

When the first owner(s) obtains a title from a Department of Motor Vehicles as proof of ownership.

New Owner Reported

When a vehicle is sold to a new owner, the Title must be transferred to the new owner(s) at a Department of Motor Vehicles.

Ownership History

CARFAX defines an owner as an individual or business that possesses and uses a vehicle. Not all title transactions represent changes in ownership. To provide estimated number of owners, CARFAX proprietary technology analyzes all the events in a vehicle history. Estimated ownership is available for vehicles manufactured after 1991 and titled solely in the US including Puerto Rico. Dealers sometimes opt to take ownership of a vehicle and are required to in the following states: Maine, Massachusetts, New Jersey, Ohio, Oklahoma, Pennsylvania and South Dakota. Please consider this as you review a vehicle's estimated ownership history.

Rental

Vehicle was registered by a rental agency.

Title Issued

A state issues a title to provide a vehicle owner with proof of ownership. Each title has a unique number. Each title or registration record on a CARFAX report does not necessarily indicate a change in ownership. In Canada, a registration and bill of sale are used as proof of ownership.

Follow Us:  facebook.com/CARFAX  [@CARFAXinc](https://twitter.com/CARFAXinc)  [About CARFAX](#)

CARFAX DEPENDS ON ITS SOURCES FOR THE ACCURACY AND RELIABILITY OF ITS INFORMATION. THEREFORE, NO RESPONSIBILITY IS ASSUMED BY CARFAX OR ITS AGENTS FOR ERRORS OR OMISSIONS IN THIS REPORT. CARFAX FURTHER EXPRESSLY DISCLAIMS ALL WARRANTIES, EXPRESS OR IMPLIED, INCLUDING ANY IMPLIED WARRANTIES OF MERCHANTABILITY OR FITNESS FOR A PARTICULAR PURPOSE.

© 2026 CARFAX, Inc., part of S&P Global. All rights reserved.
6/23/26 5:54:13 PM (CDT)